

Case

Date:26.04.2026

Article number: 102 004-22



Table of content

Information	3
Measurements	3
Colors	3

Information

The lightweight plastic shells are available in nine standard colors and made of high-impact polyethylene (PE-HD). They are also resistant to chemical influences. Color and shape are therefore retained even under extreme loads and they meet even the toughest industry-specific standards. With its handy dimensions, the case offers the cargo perfect protection with full mobility. Depending on the version, a case also meets special civil and military packaging standards, such as the ATA 300 (Category I),.

Measurements

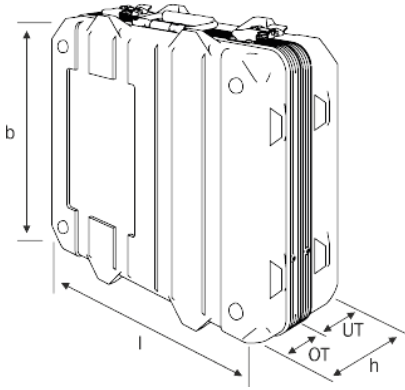

Interior (l x w x h (base + lid)) [mm]:
348 x 243 x 260 (125 + 135)

Exterior (l x w x h (base + lid)) [mm]:
385 x 295 x 285 (135 + 150)

Weight 2,6 kg

Colors



RAL: similar to 9011, black



RAL: similar to 6014, army green



RAL: similar to 9010, white



RAL: similar to 9007, silver grey



RAL: similar to 1021, yellow



RAL: similar to 2004, orange



RAL: similar to 2002, red



RAL: similar to 5002, blue



RAL: similar to 7016, dark grey



RAL: similar to 1002, desert tan

Contact

Date:26.04.2026

Thermodyne GmbH

Nordstr. 15

49086 Osnabrück

Dr.-Ing. Daniel Bätzel

+49 (0) 541 / 181 4997-95

www.thermodyne.de

info@thermodyne.de