

# Case

Date:22.04.2026

Article number: 102 024-21

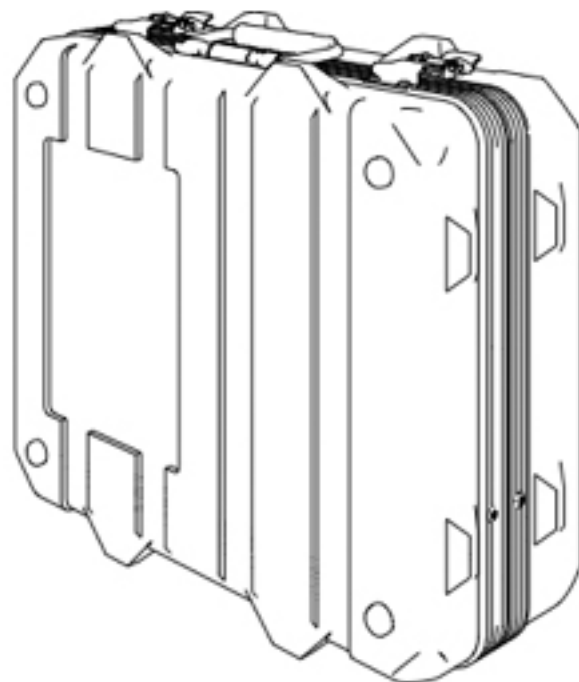

# Table of content

Information .....	3
Measurements .....	3
Colors .....	3

## Information

The lightweight plastic shells are available in nine standard colors and made of high-impact polyethylene (PE-HD). They are also resistant to chemical influences. Color and shape are therefore retained even under extreme loads and they meet even the toughest industry-specific standards. With its handy dimensions, the case offers the cargo perfect protection with full mobility. Depending on the version, a case also meets special civil and military packaging standards, such as the ATA 300 (Category I),.

## Measurements

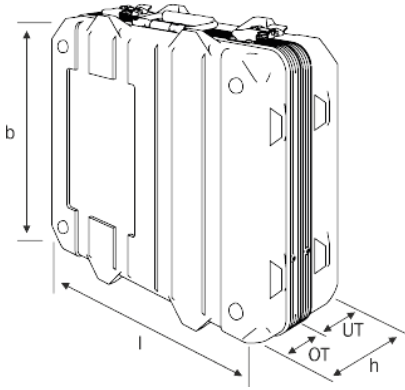

Interior (l x w x h (base + lid)) [mm]:  
640 x 405 x 145 (90 + 55)

Exterior (l x w x h (base + lid)) [mm]:  
665 x 455 x 180 (105 + 75)

Weight 4,3 kg

## Colors



RAL: similar to  
9011, black



RAL: similar to  
6014, army green



RAL: similar to  
9010, white



RAL: similar to  
9007, silver grey



RAL: similar to  
1021, yellow



RAL: similar to  
2004, orange



RAL: similar to  
2002, red



RAL: similar to  
5002, blue



RAL: similar to  
7016, dark grey



RAL: similar to  
1002, desert tan

# Contact

Date:22.04.2026

## Thermodyne GmbH

Nordstr. 15

49086 Osnabrück

Dr.-Ing. Daniel Bätzel

+49 (0) 541 / 181 4997-95

[www.thermodyne.de](http://www.thermodyne.de)

[info@thermodyne.de](mailto:info@thermodyne.de)