

Case

Date:28.04.2026

Article number: 102 178-44



Table of content

Information	3
Measurements	3
Colors	3

Information

The lightweight plastic shells are available in nine standard colors and made of high-impact polyethylene (PE-HD). They are also resistant to chemical influences. Color and shape are therefore retained even under extreme loads and they meet even the toughest industry-specific standards. Transportation boxes are particularly versatile when it comes to their fields of application. In addition to the standard range, they can be dimensioned to almost any size and are therefore suitable for a huge number of potential transport and storage goods. Depending on the version, the transport box also meets special civil and military packaging standards, such as the ATA 300 (Category I).

Measurements

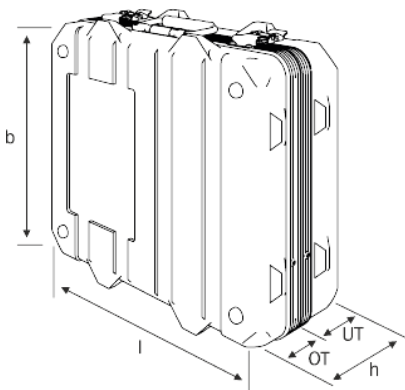

Interior (l x w x h (base + lid)) [mm]:
445 x 355 x 375 (185 + 190)

Exterior (l x w x h (base + lid)) [mm]:
465 x 410 x 415 (200 + 215)

Colors



RAL: similar to
9011, black



RAL: similar to
6014, army green



RAL: similar to
9010, white



RAL: similar to
9007, silver grey



RAL: similar to
1021, yellow



RAL: similar to
2004, orange



RAL: similar to
2002, red



RAL: similar to
5002, blue



RAL: similar to
7016, dark grey



RAL: similar to
1002, desert tan

Contact

Date:28.04.2026

Thermodyne GmbH

Nordstr. 15

49086 Osnabrück

Dr.-Ing. Daniel Bätzel

+49 (0) 541 / 181 4997-95

www.thermodyne.de

info@thermodyne.de