

Case

Date:22.04.2026

Article number: 102 182-11



Table of content

Information	3
Measurements	3
Colors	3

Information

The lightweight plastic shells are available in nine standard colors and made of high-impact polyethylene (PE-HD). They are also resistant to chemical influences. Color and shape are therefore retained even under extreme loads and they meet even the toughest industry-specific standards. With its handy dimensions, the case offers the cargo perfect protection with full mobility. Depending on the version, a case also meets special civil and military packaging standards, such as the ATA 300 (Category I),.

Measurements

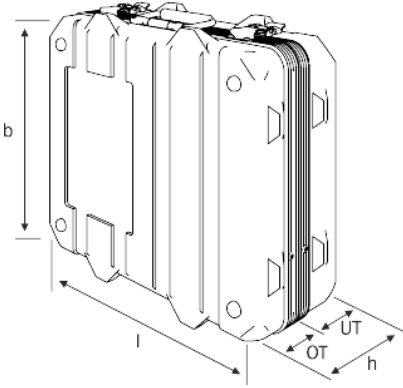

Interior (l x w x h (base + lid)) [mm]:
564 x 442 x 130 (85 + 45)

Exterior (l x w x h (base + lid)) [mm]:
610 x 490 x 170 (100 + 70)

Weight 4,6 kg

Colors



RAL: similar to
9011, black



RAL: similar to
6014, army green



RAL: similar to
9010, white



RAL: similar to
9007, silver grey



RAL: similar to
1021, yellow



RAL: similar to
2004, orange



RAL: similar to
2002, red



RAL: similar to
5002, blue



RAL: similar to
7016, dark grey



RAL: similar to
1002, desert tan

Contact

Date:22.04.2026

Thermodyne GmbH

Nordstr. 15

49086 Osnabrück

Dr.-Ing. Daniel Bätzel

+49 (0) 541 / 181 4997-95

www.thermodyne.de

info@thermodyne.de