

# Oxygen cylinders

Date:22.04.2026

Article number: 103 011 - for oxygen cylinders

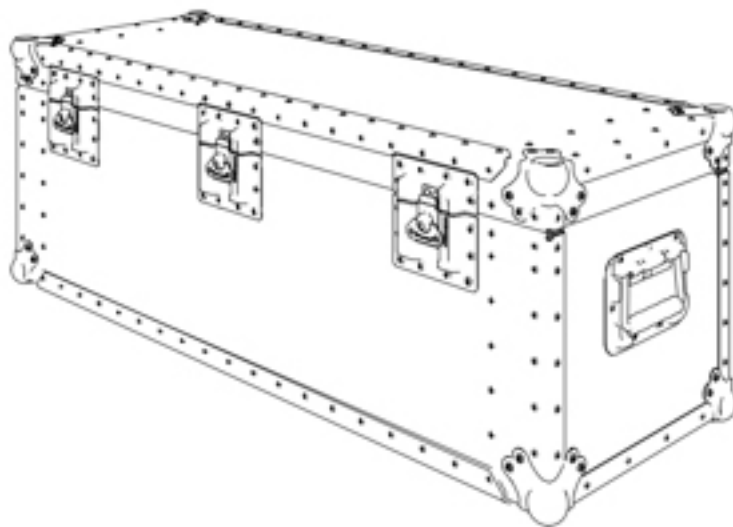

# Table of content

Information .....	3
Measurements .....	3
Colors .....	3

## Information

UN certified Hazardous Goods Container by the BAM made of lightweight aluminium for oxygen cylinders with a maximum size of 580 x 120 x 160 [mm] (11 CuFt). The shipping cases pass the HM22FB/DOT31FP requirements (flame and heat penetration requirements set forth in 49 CFR 173.168) and have passed the 280 cycle drop test of the ATA300 Cat. 1 standard. On stock available and on request with an individual labeling (e.g. laser engraved plates with property markings) or a made-to-measure interior for your equipment.

## Measurements

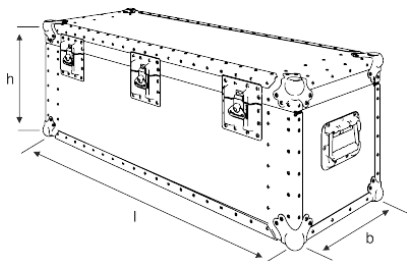

Interior (l x w x h (base + lid)) [mm]:  
580 x 120 x 160

Exterior (l x w x h (base + lid)) [mm]:  
850 x 370 x 410

## Colors

RAL: similar to 9006, stainless steel

# Contact

Date:22.04.2026

## Thermodyne GmbH

Nordstr. 15

49086 Osnabrück

Dr.-Ing. Daniel Bätzel

+49 (0) 541 / 181 4997-95

[www.thermodyne.de](http://www.thermodyne.de)

[info@thermodyne.de](mailto:info@thermodyne.de)