

Oxygen cylinders

Date:17.06.2026

Article number: 103 230 - for oxygen cylinders

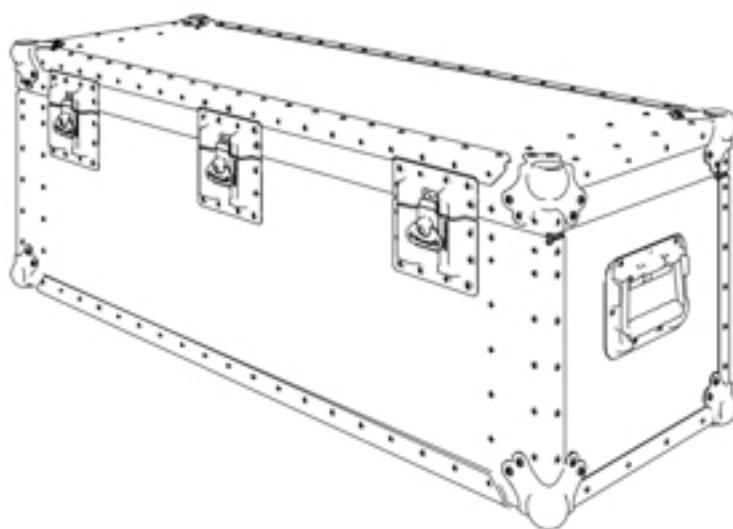

Table of content

Information	3
Measurements	3
Colors	3

Information

Hazardous Goods Container made of lightweight aluminium for oxygen cylinders with a maximum size of 955 x 250 x 380 [mm] (230 CuFt). The shipping cases pass the HM22FB/DOT31FP requirements (flame and heat penetration requirements set forth in 49 CFR 173.168) and have passed the 280 cycle drop test of the ATA300 Cat. 1 standard. On stock available and on request with an individual labeling (e.g. laser engraved plates with property markings) or a made-to-measure interior for your equipment.

Measurements

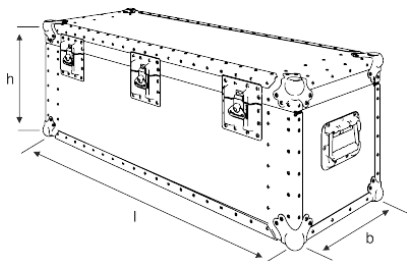

Interior (l x w x h (base + lid)) [mm]:
955 x 250 x 380

Exterior (l x w x h (base + lid)) [mm]:
1200 x 470 x 610 (520 + 90)

Colors

RAL: similar to 9006, stainless steel

Contact

Date:17.06.2026

Thermodyne GmbH

Nordstr. 15

49086 Osnabrück

Dr.-Ing. Daniel Bätzel

+49 (0) 541 / 181 4997-95

www.thermodyne.de

info@thermodyne.de